



HOISTING CATALOGUE



Hoisting & Lifting Equipment

A complete range of superior products, that comply with the European CE-Regulations. Each has been tested under severe conditions. These tools and machines are made of solid construction materials, built together into a reliable device. All hoisting equipment is delivered with a test certificate.

THIS EQUIPMENT IS FIT FOR:

- construction and machine factories
- assembly plants
- maintenance
- maritime industry and boiler construction
- agriculture
- automotive
- forestry
- etc.

Hef- & Hijswerktuigen

Een complete range hoogwaardige producten, die voldoen aan de Europese CE. Ze zijn onder zware omstandigheden getest, tevens is er gebruik gemaakt van robuuste materialen en is er gekozen voor een degelijke uitvoering. Uiteraard voldoen ze aan de hoogste eisen van veiligheid en betrouwbaarheid. Alle hef-/hijswerktuigen worden geleverd met een testcertificaat.

TOEPASSING VOOR:

- constructie- en machinebouw
- montagebouw
- onderhoud
- scheeps- en ketelbouw
- agrarische sector
- automotive
- bosbouw
- enz.

OUR BRANDS ONZE MERKEN:



KITO



RUD

HOISTING CATALOGUE

Index Inhoud

MASTERLIFT

- 4 MEC-A
Electrical Chain Hoist
- 5 MEC-AM
Electrical Chain Hoist
with Trolley
- 6 MET-A
Electrical Trolley
- 7 BK
Beam Clamp
- 7 LC
Plate Clamp
- 8 RTM
Lever Hoist
- 8 STM
Chain Block
- 9 SHM
Stage Hoist
- 10 PTM/GTM
Push and Geared Trolley
- 11 HPH
Wire Rope Pulling Hoist
- 11 DK
Mechanical Jack

KITO

- 12 ED
Electrical Chain Hoist
230V / 1 PH / 50-Hz
- 12 TMH
Plain Trolley
- 13 ER2
Electrical Chain Hoist
- 13 MR
Electrical Trolley
- 14 CX
Hand Chain
- 14 LX
Lever Hoist
- 15 CB
Hand Chain Hoist
- 15 LB
Lever Hoist
- 16 EQ
Electrical Chain Hoist

MASTERLIFT

- 4 MEC-A
Elektrische Kettingtakel
- 5 MEC-AM
Elektrische Kettingtakel
met Loopkat
- 6 MET-A
Elektrische Loopkat
- 7 BK
Balkklem
- 7 LC
Platenklem
- 8 RTM
Rateltakel
- 8 STM
Handtakel
- 9 SHM
Handtakel
- 10 PTM/GTM
Duw- en Haspelloopkat
- 11 HPH
Staaldraad-Trekapparaat
- 11 DK
Mechanische
Dommekracht

KITO

- 12 ED
Elektrische Kettingtakel
230V / 1 PH / 50-Hz
- 12 TMH
Loopkat
- 13 ER2
Elektrische Kettingtakel
- 13 MR
Elektrische Loopkat
- 14 CX
Handtakels
- 14 LX
Rateltakel
- 15 CB
Handkettingtakel
- 15 LB
Rateltakel
- 16 EQ
Elektrische Kettingtakel

BLACK BEAR

- 17 YSS/YSD
Electrical Chain Hoist
- 19 YSE
Electrical Chain Hoist
- 19 YSF
Single Phase Electrical
Chain Hoist
- 20 YSMT/YSDMT
Motorized Trolley

RUD

- 21 RM
Eye Nut
- 21 RS
Eye Bolt
- 21 VRM
Eye Nut
- 22 VRS-F
Eye Bolt
- 22 VLBG Plus
Load Ring
- 22 VWBG
Lifting Point Load Ring
- 23 VIP Chain Slings

BLACK BEAR

- 17 YSS/YSD
Elektrische Kettingtakel
- 19 YSE
Elektrische Kettingtakel
- 19 YSF
Lichtnettakel
- 20 YSMT/YSDMT
Elektrische Loopkat

RUD

- 21 RM
Oogmoer
- 21 RS
Oogbout
- 21 VRM
Oogmoer
- 22 VRS-F
Oogbout
- 22 VLBG plus
Draaibare Hijsoog
- 22 VWBG
Draaibare Oogbout
- 23 VIP Kettingwerken

MEC-A

Electrical Chain Hoist
Elektrische Kettingtakel

FEATURES

- From 0.25T up to 10 Ton
- TUV, CE and ISO certificated
- Single and Double lifting speed
- Slip clutch protection against overload
- Upper and lower limit switch
- Chain galvanized according to EN 818-7
- Control voltage 48 v
- Emergency stop
- Power supply 400V/3ph/50-hz
- Duty rating 40 %
- Electromagnetic DC Brakes
- Upper and Lower Hook
- Standard 3 m lift, higher lift possible
- Standard 2,5 m control, longer possible
- Chain bag
- Motor housing and Gearbox aluminium

EIGENSCHAPPEN

- Van 250 kg tot 10 ton leverbaar
- TUV-, CE- en ISO-gecertificeerd
- Enkel en dubbelsnelheid
- Slipkoppeling ter bescherming tegen overbelasting
- Eindschakelaar hoogste en laagste stand
- Verzinktelastketting volgens EN 818-7
- Stuurspanning 48v olt
- Voorzien van Noodstop
- Voeding 400V/3ph / 50-hz
- Inschakelduur 40 %
- Electro magnetische DC Rem
- Voorzien van boven- en onderhaak
- 3 m hijshoogte standaard, hogere hijshoogte mogelijk
- 2,5 m bedieningshoogte standaard, hogere bedieningshoogte mogelijk
- Voorzien van kettingzak
- Motorhuis / Gearbox Aluminium



Type / Type	SWL / Werklast	Speed / Snelheid	Duty Rating (ED) / Inschakelduur (ID)	Hoist Motor / Hijsmotor	Load Chain mm and Falls / Lastketting mm en parten	Headroom / bouwhoogte
single speed / enkele snelheid						
MECS-A-003	250	7,0	40%	0,9	5x15 F1	400
MECS-A-005	500	7,6	40%	0,90	6,3x19 F1	410
MECS-A-010	1000	5,0	40%	1,1	8.0x24 F1	460
MECS-A-020	2000	2,5	40%	1,10	8.0x24 F2	650
double speed / dubbele snelheid						
MECD-A-003	250	7,6/2,5	40%	0,9/0,3	5x15 F1	400
MECD-A-005	500	7,6/2,5	40%	0,9/0,3	6,3x19 F1	410
MECD-A-010	1000	5,0/1,7	40%	1,1/0,37	8.0x24 F1	460
MECD-A-020	2000	2,5/0,85	40%	1,1/0,37	8.0x24 F2	650

Type / Type	SWL / Werklast	Speed / Snelheid	Duty Rating (ED) / Inschakelduur (ID)	Hoist Motor / Hijsmotor	Load Chain mm and Falls / Lastketting mm en parten	Headroom / bouwhoogte
single speed / enkele snelheid						
MECS-A-030	3000	6,0	40%	3.0	11,2x34 F1	525
MECS-A-050	5000	3,0	40%	3.0	11,2x34 F2	860
MECS-A-750	7500	2,0	40%	3.0	11,2x34 F3	
MECS-A-1000	10000	3,0	40%	2x3	11,2x34 F4	
double speed / dubbele snelheid						
MECD-A-030	3000	6,0/2,0	40%	3.0	11,2x34 F1	525
MECD-A-050	5000	3,0/1,0	40%	3.0	11,2x34 F2	860
MECD-A-750	7500	2,0/0,67	40%	3.0	11,2x34 F3	
MECD-A-1000	10000	3,0/1,0	40%	2x3/1	11,2x34 F4	

Other specifications on request
Overige specificaties op aanvraag beschikbaar

MEC-AM

Electrical Chain Hoist with Trolley Elektrische Kettingtakel met Loopkat

FEATURES

- From 250 Kg up till 10 Ton
- TUV, CE and ISO certificated
- Singel and Double lifting-speed
- Slip clutch protection against overload
- Upper and lower limed switch
- Chain galvanized according to EN 818-7
- Control voltage 48 v
- Emergency stop
- Power supply 400V/3ph/50-hz
- Duty rating 40 %
- Electromagnetic DC Brake
- With lower Hook
- Standard 3 m lift, higher lift possible
- Standard 2,5 m control, longer possible
- Chain bag
- Motor housing and Gearbox aluminum
- Horizontal Guide wheel
- Guide wheel to protect jumping
- Singel and travel speed

EIGENSCHAPPEN

- Van 250 kg tot 10 ton leverbaar
- TUV-, CE- en ISO-gecertificeerd
- Enkel en dubbelsnelheid
- Slijpkoppeling ter bescherming tegen overbelasting
- Eindschakelaar hoogste en laagste stand
- Verzinkte lastketting volgens EN 818-7
- Stuurspanning 48 volt
- Voorzien van Noodstop
- Voeding 400V/3ph/50-hz
- Inschakelduur 40 %
- Electro magnetische DC Rem
- Voorzien van onderhaak
- 3 m hijshoogte standaard, hogere hijshoogte mogelijk
- 2,5 m bedieningshoogte standaard, hogere bedieningshoogte mogelijk
- Voorzien van kettingzak
- Motorhuis / Gearbox Aluminium
- Loopkat voorzien van geleide rollen
- Opspring beveiliging
- Enkel en dubbelsnelheid



Type / Type	SWL / Werklast	Flange-width* / Balk-breedte*	Lifting Speed / Hijs-snelheid	Traveling Speed / Reis-snelheid	Headroom / bouw-hoogte
single speed / enkele snelheid					
MECS-AM-003	250	74/140	7	13,5	398
MECS-AM-005	500	74/140	7,6	13,5	398
MECS-AM-010	1000	74/140	5,0	13,5	460
MECS-AM-020	2000	74/140	2,5	13,5	650
double speed / dubbele snelheid					
MECD-AM-003	250	74/140	70/2,3	20/6,7	398
MECD-AM-005	500	74/140	7,6/2,5	20/6,7	398
MECD-AM-010	1000	74/140	5,0/1,7	20/6,7	460
MECD-AM-020	2000	74/140	2,5/0,85	20/6,7	650

Type / Type	SWL / Werklast	Flange-width* / Balk-breedte*	Lifting Speed / Hijs-snelheid	Traveling Speed / Reis-snelheid	Headroom / bouw-hoogte
single speed / enkele snelheid					
MECS-AM-030	250	100/170	6	13,5	398
MECS-AM-050	500	100/170	3	13,5	398
MECS-AM-750	1000	100/170	2	13,5	460
MECS-AM-1000	2000	150/220	3	13,5	650
double speed / dubbele snelheid					
MECD-AM-030	250	100/170	6,0/2,0	20/6,7	398
MECD-AM-050	500	100/170	3,0/1,0	20/6,7	398
MECD-AM-750	1000	100/170	2,0/0,6	20/6,7	460
MECD-AM-1000	2000	150/220	3,0/1,0	20/6,7	650

* Other flange width on request

* Andere balkbreedte op aanvraag

Other specifications on request

Overige specificaties op aanvraag beschikbaar

MET-A

Electrical Trolley Elektrische Loopkat

FEATURES

- From 250 kg up to 10 ton
- TUV, CE and ISO certificated
- Single and double traveling speed
- Control voltage 48 v
- Power supply 400V/3ph/50-hz
- Duty rating 40 %
- Standard 2,5 m control, longer possible
- Horizontal Guide wheel
- Guide wheel to protect jumping

EIGENSCHAPPEN

- Van 250 kg tot 10 ton leverbaar
- TUV-, CE- en ISO gecertificeerd
- Enkel en dubbelsnelheid rijden
- Stuurspanning 48 volt
- Voorzien van Noodstop
- Voeding 400V/3ph/50-hz
- inschakelduur 40 %
- 2,5 m bedieningshoogte standaard, hogere bedieningshoogte mogelijk
- Loopkat voorzien van geleide rollen
- Opspringbeveiliging

Type / Type	SWL / Werklast kg	Speed / Snelheid m/min	Flange-width / Balkbreedte mm	Net Weight / Netto gewicht kg
single speed / enkele snelheid				
METS-A-005	500	13,5	74/140	26
METS-A-010	1000	13,5	74/100	26
METS-A-020	2000	13,5	74/100	36
METS-A-030	3000	13,5	100/170	52
METS-A-050	5000	13,5	100/170	68
METS-A-750	7500		100/170	
METS-A-1000	10000		150/220	
double speed / dubbele snelheid				
METD-A-005	500	20,0/6,7	74/100	33
METD-A-010	1000	20,0/6,7	74/100	36
METD-A-020	2000	20,0/6,7	74/100	40
METD-A-030	3000	18,0/6,0	100/170	56
METD-A-050	5000	18,0/6,0	100/170	76
METD-A-750	7500	20,0/11	100/170	
METD-A-1000	10000	20,0/11	150/200	

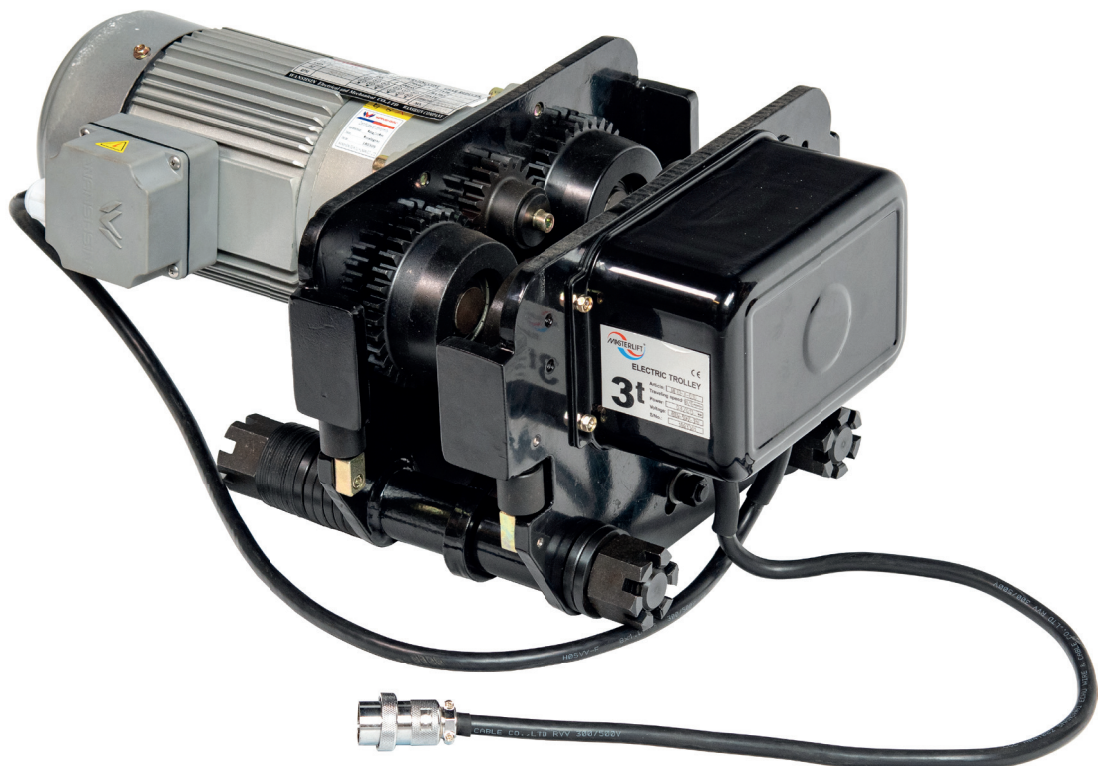

Other specifications on request
Overige specificaties op aanvraag beschikbaar

BK

Beam Clamp Balkklem

FEATURES

- Firm anchor point for lifting and pulling
- Spindle enables quick mounting
- Safety factor 4:1
- Built-in suspension for INP and IPE-beams

EIGENSCHAPPEN

- Geeft een vast verankeringspunt
- Voor hijsen en trekken
- Snelle montage door spindel
- Veiligheidsfactor 4:1
- Ophanging voor INP en IPE balken

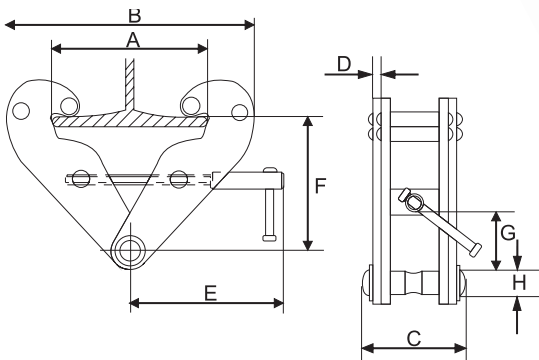

Capacity / Werklast (T)	1	2	3	5	10
Beam width / Balkbreedte (mm)	75-230	75-230	80-345	80-345	90-350
Dimensions / Afmetingen (mm)					
A (max)	240	240	355	355	360
B (min-max)	192-367	192-367	243-520	243-520	272-532
C	94	102	132	142	180
D	4	6	8	10	12
E	194	194	241	241	284
F (min-max)	102-154	102-154	133-223	133-223	155-234
G	22	22	38	35	47
H	20	20	22	28	38
Weight / Gewicht (kg)	4	4.8	9.8	11.6	17

LC

Plate Clamp Platenklem

FEATURES

- Safety lifting clamps with universal eye for horizontal and vertical use
- Hinging in all directions
- For safe transport of steel plates and constructions
- Securing in open and closed position

EIGENSCHAPPEN

- Veiligheids- hijsklem met universeel hijs oog voor horizontaal en verticaal gebruik naar alle kanten scharnierend
- Voor transport van stalen platen en constructies
- Vergrendeling in gesloten positie

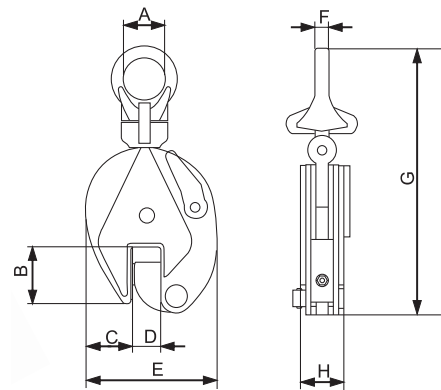

Capacity / Werklast (T)	0.5	1	2	3
Jaws width / Bekopening (mm)	0-15	0-20	0-25	0-30
Dimensions / Afmetingen (mm)				
A	30	48	68	74
B	43	63	78	85
C	34	50	61	57
D	0-17	0-22	0-27	0-32
E	106	145	174	207
F	10	12	16	20
G	216	292	369	428
H	50	66	76	102
Weight / Gewicht (kg)	2	4.5	7.3	15

RTM

Lever Hoist Rateltakel



FEATURES

- Suitable for pulling, lifting and lashing in all directions
- Safety factor 4:1
- Standard equipped for 1,5 m lifting height
- Galvanized Grade 80 plated load chain according to EN 818-7
- 360° turnable, top and bottom safety hooks with swivel bearings
- Other chain lengths available
- User-friendly by rapid slack chain adjustment
- Enclosed gearcase and break covers
- Equipped with asbestos free brake discs

EIGENSCHAPPEN

- Geschikt voor trekken, hijsen en spannen in alle richtingen
- Veiligheidsfactor 4:1
- Standaard uitgerust met 1,5 m hijshoogte
- Gegalvaniseerde lastketting volgens EN 818-7
- Met elke kettlinglengte leverbaar
- 360° draaibare, gelagerde boven- en onderhaak met veiligheidsklep
- Bedieningsgemak door ketting vrijloopsysteem
- Voorzien van asbestvrije remschijven

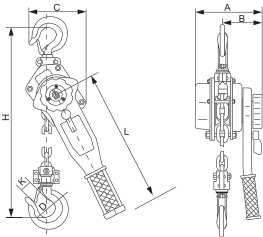

0.75t, 1.5t, 3t

Capacity / Werklast (T)	0.25	0.5	0.75	1.5	3	6	9
Standard lifting height / Standaard hijshoogte	1.5	1.5	1.5	1.5	1.5	1.5	1.5
Number of falls / Aantal kettlingparten	1	1	1	1	1	1	1
Required force on lever with max. load (kg) / Uit te oefenen kracht op de hendel max.	25	34	14	24	32	34	36
Chain / Kettingdiameter	4x12	5x15	6x18	8x24	10x30	10x30	10x30

Dimensions / Afmetingen (mm)

A	92	105	148	176	195	195	195
B	72	78	88	102	109	109	109
C	85	80	135	162	211	254	319
D	30	35	37	45	50	64	85
H (min. bouwhoogte/ min. close height)	230	260	320	380	480	620	700
K	25	30	26	32.5	38	48	50
L	160	300	290	420	420	420	420
Weight / Gewicht (kg)	1.8	4	7.7	11.8	21	32	47

STM

Chain Block Handtakel



FEATURES

- Safety factor 4:1
- Standard 3 m lifting height
- Other lifting heights available
- Galvanized Grade 80 plated load chain according to EN 818-7
- 360° turnable, top and bottom safety hooks with swivel bearings operation height 2,5 m equipped with asbestos free brake discs
- All gearing with bearings
- Type with double brake-locking

EIGENSCHAPPEN

- Veiligheidsfactor 4:1
- 3 m standaard hijshoogte
- Elke hijshoogte leverbaar
- Gegalvaniseerde lastketting volgens EN 818-7
- 360° draaibare, gelagerde boven- en onderhaak met veiligheidsklep
- Bedieningshoogte 2,5 m
- Voorzien van asbestvrije remschijven
- Alle tandwielen zijn gelagerd
- Uitvoering met dubbele rempal

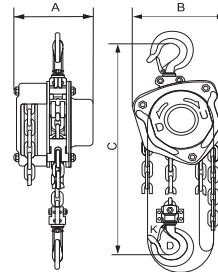

0.5t -2t

Capacity / Werklast (T)	0.5	1	1.5	2	3	5	10	20
Standard lifting height / Standaard hijshoogte	3	3	3	3	3	3	3	3
Number of falls / Aantal kettlingparten	1	1	1	1	2	2	4	8
Chain / Kettingdiameter	6x18	6x18	8x24	8x24	8x24	10x30	10x30	10x30

Dimensions / Afmetingen (mm)

A	137.5	146.5	170	170	170	190	190	209
B	137	162	183	194	220	288	384	625
C (min. bouwhoogte/ min. close height)	270	317	399	414	465	618	798	890
D	35	35.5	45	42.5	50	64	85	110
K	28	26	32.5	32	37	46	50	81
Weight / Gewicht (kg)	8.4	10.5	15.5	18.5	21.2	41.8	81.7	173

SHM

Stage Hoist Podiumtakel

FEATURES

- Safety factor 4:1
- Standard 10 m lifting height
- Other lifting heights available
- Galvanized Grade 80 plated load chain according to EN 818-7
- 360° turnable, top and bottom safety hooks with swivel bearings
- Operation height 9,5 m
- Equipped with asbestos free brake discs
- All gearing with bearings
- Type with double brake locking
- Including Chain bag
- Free brake discs

EIGENSCHAPPEN

- Veiligheidsfactor 4:1
- 10 m standaard hijshoogte
- Elke hijshoogte leverbaar
- Gegalvaniseerde lastketting volgens EN 818-7
- 360° draaibare, gelagerde boven- en onderhaak met veiligheidssklep
- Bedieningshoogte 9,5 m
- Voorzien van asbestvrije remschijven
- Alle tandwielen zijn gelagerd
- Uitvoering met dubbel rempal
- Inclusief kettingzak

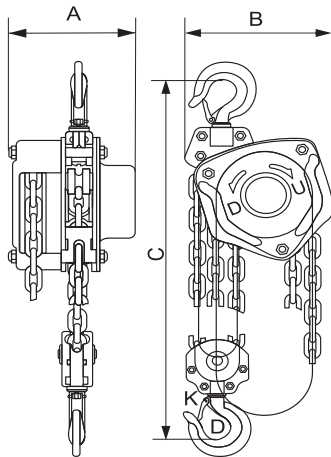

Capacity / Werklast (T)	0.5	1	1.5	2
Standard lifting height / Standaard hijshoogte	3	3	3	3
Number of falls / Aantal kettingparten	1	1	1	1
Chain / Kettingdiameter	6x18	6x18	8x24	8x24

Dimensions / Afmetingen (mm)

A	137.5	146.5	170	170
B	137	162	183	194
C (min. bouwhoogte/ min. close height)	270	317	399	414
D	35	35.5	45	42.5
K	28	26	32.5	32
Weight / Gewicht (kg)	8.4	10.5	15.5	18.5

PTM
Push Trolley
Duwloopkatten

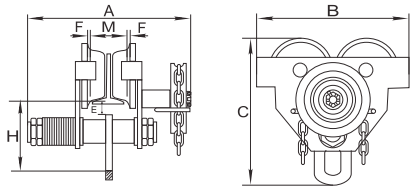

FEATURES

- Suitable for INP and IPE profiles
- Secured against wheel breakage
- Adjustable to runner rail
- Precision wheels with sealed bearings
- Each operation height available (hand-driven operation)
- Extension axles for wider beams available

EIGENSCHAPPEN

- Geschikt voor INP en IPE profielen
- Wielbreukbeveiliging
- Instelbare flensbreedte
- Precisie loopwielen voorzien van gesloten lagere
- Elke bedieningshoogte leverbaar (GTM)
- Verlengassen voor grotere balkbreedtes verkrijgbaar

Capacity / Werklast (T)	0.5	1	2	3	5	10
Min. radius / min. radius (mm)	0.9	1	1.1	1.3	1.4	1.7
Runner rail width / M flensbreedte (mm)	64-152	64-203	88-203	102-203	114-203	125-203

Dimensions / Afmetingen (mm)

A	264	335	353	371	393	436
B	216	260	300	345	390	470
C	195	239	286	336	393	500
E	31	32,5	31	35	37	45
F	≈3	≈3	≈3	≈3	≈3	≈3
H (min. bouwhoogte/ min. close height)	110	136	161	185	220	280
Weight / Gewicht (kg)	8.6	15.4	23	40	50	97

GTM
Geared Trolley
Haspelloopkatten

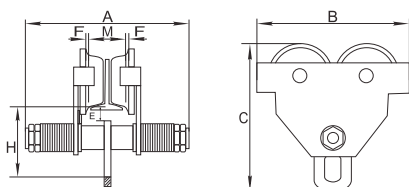

Capacity / Werklast (T)	1	2	3	5	10	20
Min. radius / min. radius (mm)	1	1.1	1.3	1.4	1.7	3.5
Runner rail width / M flensbreedte (mm)	64-203	88-203	102-203	114-203	125-203	150-203

Dimensions / Afmetingen (mm)

A	390	400	430	444	489	535
B	260	300	345	390	470	716
C	239	286	336	393	500	649
E	32,5	31	35	37	45	65
F	≈3	≈3	≈3	≈3	≈3	≈3
H (min. bouwhoogte/ min. close height)	136	161	185	220	280	233
Weight / Gewicht (kg)	19.9	28.5	46	57	103	344

HPH

**Wire Rope Pulling Hoist
Staaldraad-Trekapparaat**

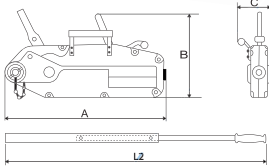

FEATURES

- For lifting, pulling and lashing in all directions
- Telescopic lever
- Lightweight steel body
- Standard with 20 m wire rope set and safety hook on winder
- Can be used with comparable type of wire ropes
- Secured against overloading

EIGENSCHAPPEN

- Voor hijs-, trek- en spanwerkzaamheden in elke richting
- Uitschuifbare hefboom
- Lichtgewicht stalen huis
- Standaard incl. 20 m Draadset met veiligheidstaak op haspel
- Beveiligd tegen overbelasting

Lifting capacity / Hijsvermogen	0.8	1.6	3.2
Pulling capacity / Trekvermogen	1.3	2.5	5
Cable diameter / Draad diam. (mm)	8.3	11	16
L2 (cm)	80	120	120

Dimensions / Afmetingen (mm)			
A	435	545	655
B	245	286	345
C	70	92	116
Weight without cable / Gewicht zonder draad	7	12	23

DK

**Mechanical Jack
Mechanische Dommekracht**

FEATURES

- Safety crank with brake for securing the load in any position (reverse secured)
- Safe operation by twin pawls securing
- Folding handle for easy storage and transport
- 100% load capacity on head and 70% on base

EIGENSCHAPPEN

- Veiligheidsslinger voorzien van rem voor lastvergrendeling in iedere stand (terugloop-beveiliging)
- Veilige werking door dubbel palsysteem
- Geringe opslagruimte en eenvoudig transport door inklapbare zwengel
- 100% belastbaar op de kop 70% op voet

Capacity on head / Werklast kop	3	5	10	16	20
Power on crank / Trekkraft op hendel	28	28	56	64	64
Lifting height / Hefhoogte	350	350	410	320	300
H (min. close height) / H (bouwhoogte)	730	730	800	800	860

Dimensions / Afmetingen (mm)

A	197	189	250	275	275
B	200	239	293	320	335
C	296	335	498	514	529
D	130	140	140	150	150
E	60	71	86	95	100
F	70	80	85	95	100
G	140	170	170	180	180
K	127	127	248	250	250
R	250	250	300	300	380
Weight / Gewicht (kg)	21.2	28.5	46.8	65	75

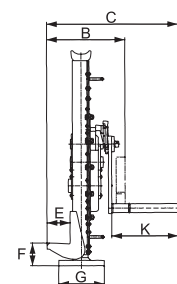
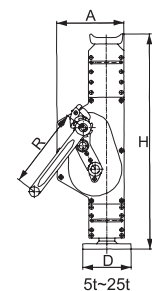
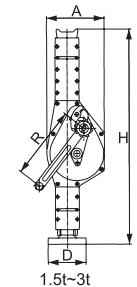

ED

Electrical Chain Hoist Elektrische Kettingtakel

FEATURES

- 230 V/50 Hz single-phase
- Hook suspension
- High-performance mechanical brake with friction clutch
- Range limit switch for lifting
- Single or dual lifting speed
- Weather-tight and corrosion resistant
- Aluminum gear casing
- Nickel-plated load chain, grade DAT (G 80) in accordance with standard EN 818-7

OPTIONS

- Radio remote control
- TMH plain trolley
- Foam hook protector

For more information about Kito products, please contact our team at Holland Hoisting B.V.

EIGENSCHAPPEN

- 230 V/50 Hz enkel fase
- Haak ophanging
- Hoogwaardig mechanische rem met frictiekoppeling
- Eindschakelaar
- Enkele of dubbele snelheid
- Wind/water dicht en corrosiebestendig
- Aluminum omhulsel
- Vernikkelde lastketting, grade DAT (G 80) in overeenstemming met standaard EN 818-7

OPTIES

- Radiografische afstandsbediening
- TMH loopkat
- Schuimhaak beschermer

Voor meer informatie over de Kito-producten, neem contact op met het team van Holland Hoisting B.V.



Type	ED06-S	ED06-ST	ED10-S	ED10-ST	ED16-S	ED16-ST	ED18-S	ED18-ST	ED24-S	ED24-ST	ED48-S	ED48-ST
Capacity, kg / Werklast	60	60	100	100	160	160	180	180	240	240	480	480
Chain Falls / Aantal parten	1	1	1	1	1	1	1	1	1	1	2	2
Rating, % ED / ID %	30	30	30	30	30	30	20	20	30	30	30	30
FEM-Classification	1Am	1Am	1Am	1Am	1Am	1Am	1Am	1Am	1Am	1Am	1Am	1Am
Lifting speed, m / min / hijsnelheid	20.1	20.1/4.0	12.5	12.5/3.0	19.2	19.2/4.0	7.7	7.7/3.0	12.9	12.9/3.0	6.4	6.4/2.0
Net Weight, kg / Net gewicht	11.5	12	11.5	12	15.5	16	11.5	12	15.5	16	21	21
Headroom C,mm/ Hooftruimte	315	315	315	315	330	330	315	315	330	330	520	520

TMH

Plain Trolley Loopkat



ER2
Electrical Chain Hoist
Elektrische Kettingtakel



FEATURES

- 400 V/50 HZ
- 24 V control voltage
- Single and dual lifting speed
- Frequency inverter for dual lifting speeds
- Overload limiter thanks to carbon friction clutch
- Operating hours counter/ load cycle counter
- Range limit switch for lifting/lowering
- Thermal motor protection
- Nickel-plated load chain, grade DAT (G 80) in accordance with standard EN 818-7

EIGENSCHAPPEN

- 400 V/50 HZ
- 24 V stuurspanning
- Enkel of dubbel snelheid
- Frequentieomvormer voor dubbelsnelheid
- Overlast beveiliging met carbon-frictiekoppeling
- Inschakelduur teller/ laadcyclus teller
- Eindschakelaar voor hijsen en zakken
- Thermische motorbescherming
- Vernikkelde lastketting grade DAT(80) in overeenstemming met de standaard EN 818-7

Capacity kg	Product code	Body size	Lifting Motor		Lifting Motor m/min	Load Chain			Classifications	Testload	Weight	Extra weight		
			Output	Rating ED		50-Hz		Diameter					X	Chain fall
						Fast	Slow							
125	ER2-001 IH	B	0,56	40/20	Preset	16,6	2,8	4,3	x	1	M6/3m	156kg	27	0,42
					Adjustable		1,4							
250	ER2-003 IS	C	0,9	40/20	Preset	10,8	1,8	6,0	x	1	M6/3m	313kg	36	0,81
					Adjustable		0,9							
500	ER2-003 IH	C	0,9	40/20	Preset	15,7	2,6	6,0	x	1	M6/3m	625kg	32	36
					Adjustable		1,3							
	ER2-005 IL	D	0,56	40/20	Preset	4,5	0,8	7,7	x	1	M5/2m	1,25	45	1,33
					Adjustable		0,4							
ER2-005 IS	D	0,9	40/20	Preset	8,5	1,4	7,7	x	1	M5/2m	1,25	52	2,3	
				Adjustable		0,7								
1000	ER2-010 IL	E	1,8	40/20	Preset	4,2	0,7	10,2	x	1	M4/1Am	2,5	73	89
					Adjustable		0,3							
ER2-010 IS	E	1,8	40/20	Preset	8,2	1,4	11,2	x	1	M4/1Am	3,13	100	2,8	
				Adjustable		0,7								
1600	ER2-016 IS	E	3,5	40/20	Preset	5,3	0,9	10,2	x	1	M4/1Am	2,5	73	89
					Adjustable		0,4							
2000	ER2-020 IL	F	3,5	40/20	Preset	4,3	0,7	11,2	x	1	M4/1Am	3,13	100	2,8
					Adjustable		0,4							
ER2-020 IS	F	3,5	40/20	Preset	8,2	1,4	11,2	x	1	M4/1Am	3,13	100	2,8	
				Adjustable		0,7								
2500	ER2-025 IS	F	3,5	40/20	Preset	6,6	1,1	11,2	x	1	M4/1Am	3,13	100	2,8
					Adjustable		0,6							
3200	ER2-032 IS	E	3,5	40/20	Preset	5,2	0,9	10,2	x	2	M4/1Am	4	105	4,7
					Adjustable		0,4							
5000	ER2-050 IS	F	3,5	40/20	Preset	3,3	0,6	11,2	x	2	M4/1Am	6,25	128	5,6
					Adjustable		0,3							

MR
Electrical Trolley
Elektrische Loopkat

OPTIONS

- Radio remote control
- Step less speed control
- Limit lock = programmable limit switch to restrict and define the hook path when lifting and lowering
- Foam hook protector
- Plain, geared or motorized trolley
- Special voltages on request

OPTIES

- Radiografische afstandsbediening
- Traploze snelheidsregeling
- Limiet vergrendelen= instelbare eindschakelaar
- Schuimhaak beschermer
- TMH, TSG loopkat
- Speciale voltage op aanvraag

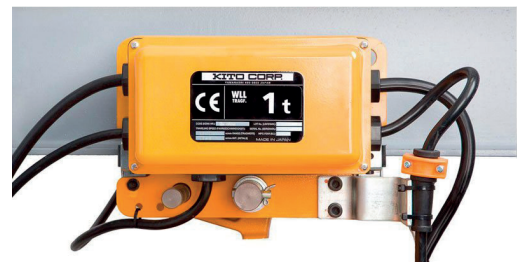

CX

Hand Chain Hoist Aluminum Body Handtakel met Aluminium Body

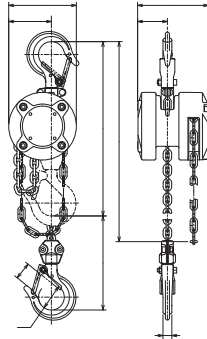

FEATURES

- Extremely lightweight
- High-quality aluminum housing
- Overload limiter as standard
- Nickel-plated load chain, grade V (G 100) in accordance with standard EN 818-7

OPTIONS

- Belt pouch for CX 003
- Chain container

EIGENSCHAPPEN

- Extreem licht gewicht
- Hoog kwaliteit aluminium behuizing
- Standaard overlastbeveiliging
- Vernikkelde lastketting, grade V (G 100) in overeenstemming met de standaard EN 818-7

OPTIES

- Riemzakje voor de CX 003
- Kettingbak

Type / Type	CX003	CX005
Capacity kg / Werklast kg	250	500
Standard lift m / Standaard hijshoogte m	2.5	2.5
Hand Chain Folded Length m	2.0	2.0
Hand pull to lift Full Load daN	14.7	18.7
Chain pull to Lift Load 1 meter m	33.8	42.8
Load Chain diameter mm / Lastketting diameter mm	3.2 x 9.0	4.3 x 12.1
Chain fall / Aantal parten	1	1
Net Weight kg / Net gewicht kg	2.4	4.5
Test Weight kg / Testgewicht kg	375	750
Weight for additional 1 m lift kg / Extra gewicht kg	0.4	0.9

Type	CX003	CX005
a	88	101
b	84	102
c	217	260
d	53	66
e	37	44
g	21	24,5
s	32	35,5
t	11	12

LX

Lever Hoist Rateltakel

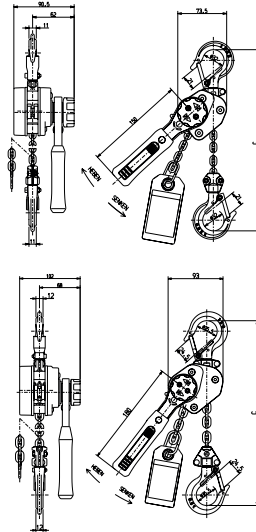

FEATURES

- Compact and lightweight construction
- Freewheel function
- Nickel-plated load chain, grade V (G 100) in accordance with standard EN 818-7

OPTIONS

- Belt pouch for LX 003

EIGENSCHAPPEN

- Compact en licht van gewicht
- Vrijeloop functie
- Vernikkelde lastketting, grade V (G 100) in overeenstemming met standaard EN 818-7

OPTIES

- Riemzakje voor de LX 003

Type / Type	CX003	CX005
Capacity kg / Werklast kg	250	500
Standard lift m / Standaard hijshoogte m	1.5	1.5
Hand pull to lift Full Load daN	20	31
Load Chain diameter mm / Lastketting diameter mm	3.2 x 9.0	4.3 x 12.0
Chain fall / Aantal parten	1	1
Net Weight kg / Net gewicht kg	1.7	2.7
Test Weight kg / Testgewicht kg	380	750
Weight for additional 1 m lift kg / Extra gewicht kg	0.2	0.4

Type	CX003	CX005
a	90,5	102,0
b	73,5	93,0
c	205,0	246,0
d	150	180,0
e	62,0	68,0
g	21,0	24,5
s	32,0	32,5
t	11,0	12,0

CB

Hand Chain Hoist Handkettingtakel



FEATURES

- Shock-resistant double gear casing
- Robust mechanical brake for increased safety
- Zero-maintenance bearings
- Double-pawl spring system as an additional safety feature
- Forged load hook with wide opening
- Nickel-plated load chain, grade V (G 100) in accordance with standard EN 818-7

EIGENSCHAPPEN

- Val- en stootbestendig door dubbel behuizing
- Robuuste mechanische rem voor extra veiligheid
- Onderhoudsvrije lagers
- Dubbele pal veer system als extra veiligheid functie
- Gesmede last haak met wijde opening
- Vernikkelde lastkettting, grade V (G 100) in overeenstemming met de standaard EN 818-7

OPTIONS

- TSG geared trolley
- TSP plain trolley
- Overload limiter (OLL)
- Various chain container sizes
- Stainless steel chain and hook for certain sizes

OPTIES

- TSG loopkat
- TSP loopkat
- Overlastbeveiliging (OLL)
- Diversen maten ketttingbakken
- Roestvrijstalen kettting voor bepaalde takels

Type / Type	CB005	CB010	CB015	CB020	CB025	CB030	CB050	CB075	CB100	CB150	CB200
Capacity kg / Werklast	500	1000	1500	2000	2500	3000	5000	7500	10000	15000	20000
Standard lift m / Standaard hijshoogte m	3,0	3,0	3,0	3,0	3,0	3,0	3,0	3,5	3,5	3,5	3,5
Hand pull to lift Full Load daN	23,5	28,4	34,3	35,3	32,3	35,3	33,3	34,3	35,3	36,3	35,2 X 2
Chain pull to Lift Load 1 meter m	25	43	57	70	99	114	198	297	396	594	396 X 2
Load Chain diameter mm / Lastkettting diameters mm	5.0 x 15.1	6.3 x 19.1	7.1 x 21.2	8.0 x 24.2	9.0 x 27.2	7.1 x 21.2	9.0 x 27.2	9.0 x 27.2	9.0 x 27.2	9.0 x 27.2	9.0 x 27.2
Chain fall / Aantal parten	1	1	1	1	1	2	2	3	4	6	8
Net Weight kg / Net gewicht kg	11,0	12,5	15,5	20,0	27,0	24,0	41,0	63,0	83,0	155,0	235,0
Weight for additional 1 m lift kg / Extra gewicht kg	1,5	1,8	2,1	2,3	2,7	3,2	4,4	6,2	7,9	11,4	15,8

LB

Lever Hoist Rateltakel



FEATURES

- Unique freewheel function
- Fine-toothed precision gearing to reduce required force
- More robust and ergonomic lever
- High-performance mechanical brake
- Nickel-plated load chain, grade V (G 100) in accordance with standard EN 818-7

EIGENSCHAPPEN

- Unieke vrijeloopfunctie
- Fijn precisietandwiel om de vereiste kracht te verminderen
- Robuuste en ergonomische takel
- Hoog prestatie mechanische rem
- Vernikkelde lastkettting, grade V (G 100) in overeenstemming met de standaard EN 818-7

OPTIONS

- Overload limiter (OLL)
- Without freewheel function (OF)
- Overload signal (LOS)
- Shipyard hook set (top and bottom hook)

OPTIES

- Overlastbeveiliging (OLL)
- Zonder vrijeloop functie (OF)
- Over belasting signaal (LOS)
- Scheepsbouwhaakset (boven en onder)

Type / Type	LB-008	LB-010	LB-016	LB-025	LB-032	LB-063	LB-090
Capacity kg / Werklast kg	800	1000	1600	2500	3200	6300	9000
Standard lift m / Standaard hijshoogte m	1,5	1,5	1,5	1,5	1,5	1,5	1,5
Hand pull to lift Full Load daN	28,4	35,3	33,3	36,3	36,3	37,2	38,2
Load Chain diameter mm / Lastkettting diameter mm	5,6 x 15,7	5,6 x 15,7	7,1 x 19,9	8,8 x 24,6	10 x 28,0	10 x 28,0	10 x 28,0
Chain fall / Aantal parten	1	1	1	1	1	2	3
Net Weight kg / Net gewicht kg	5,7	5,9	8,0	11,2	15,0	26,0	40,0
Headroom C, mm	280	300	335	375	395	540	680
Weight for additional 1 m lift kg / Extra gewicht kg	0,7	0,7	1,1	1,7	2,3	4,7	7,0

EQ

Electrical Chain Hoist Elektrische Kettingtakel

FEATURES

- Frequency inverter
- 380-440V / 3 phase
- Overload protection via frequency inverter and friction clutch
- Counter hour meter
- Upper-lower limit switch
- Pull-rotor motor brake
- Nickel plated load chain class DAT (G80) Norm EN 818-7
- Plastic Chain container
- Ergonomic push button control
- Control voltage 24V DC
- Aluminum die-cast body small, light, rugged
- High duty rating FEM 3m / ISO M6 rating through 500kg

EIGENSCHAPPEN

- Frequentieomvormer
- 380-440V / 3 phase
- Overlastbeveiliging via frequentieomvormer en frictiekoppeling
- Urenteller
- Boven-onder eindschakelaar
- Trek rotor motorrem
- Vernikkelde lastketting klasse DAT (G80) Norm EN 818-7
- Plastic kettingbak
- Ergonomische PBC
- Stuurspanning 24V DC
- Aluminium gegoten body, klein, licht, gehard
- Hoge belastingswaarde FEM 3m / ISO M6 beoordeling via 500kg



Type / Type	Capacity kg	Body Size	Standard Lift, m	Traversing Motor		Lifting speed m/min			Load Chain	Chain Fall	FEM	Weight kg	Headroom	Entire length
				Output KW	Rating % ED	High 0-30% WLL	High 30-100% WLL	Low						
EQ001 IS	125	C	3	0,5	40 / 20	22,1	17,0	2,8	5.6 x 15.7	1	3m	30	395	417
EQ003 IS	250	C	3	0,5	40 / 20	13,0	10,0	1,7	5.6 x 15.7	1	3m	30	395	417
EQ005 IS	500	C	3	0,75	40 / 20	9,9	7,6	1,3	5.6 x 15.7	1	3m	32	410	417
EQ010 IS	1000	D	3	1,5	40 / 20	9,2	7,1	1,2	7.1 x 19.9	1	3m	42	465	433

YSS/YSD • 400V / 3ph / 50Hz
With Electronic
Overload Limiter
Met elektronische
overlastbeveiliging

FEATURES

- Galvanized load chain according to EN 818-7 class H80B
- Electrical and mechanical brakes
- Lifting height 3 m standard
- Operation height 2,5 m
- With top and bottom hook
- Chain bag (up to 3 m standard)
- Other lifting height available
- Push-button switch with emergency stop
- High duty rating

EIGENSCHAPPEN

- Verzinkte lasketting volgens EN 818-7 klasse H80B
- Elektrische en mechanische rem
- Hijshoogte 3 m standaard
- Bedieningshoogte 2,5 m
- Met boven- en onderhaak
- Kettingzak (standaard t/m 3 m)
- Elke andere hijshoogte leverbaar
- Met drukknopkast inclusief noodstop
- Hoge inschakelduur

Duty rating 40%
 Power supply 400V / 3ph
 Control power 48V

YSS IS WITH SINGLE SPEED
 YSD IS WITH DOUBLE SPEED

Inschakelduur van 40%
 voeding 400V / 3ph
 Stuurstroombediening 48V

YSS IS MET ENKELE SNELHEID
 YSD IS MET DUBBELE SNELHEID



YSS/YSD • 400V / 3ph / 50Hz

With Electronic Overload Limiter
Met Elektronische Overlastbeveiliging

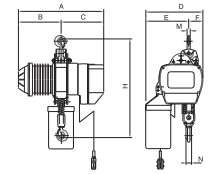

2,5 TON

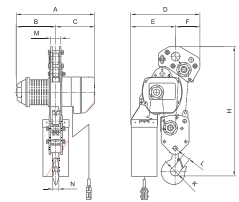

7,5 TON

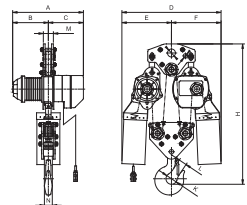

10 TON

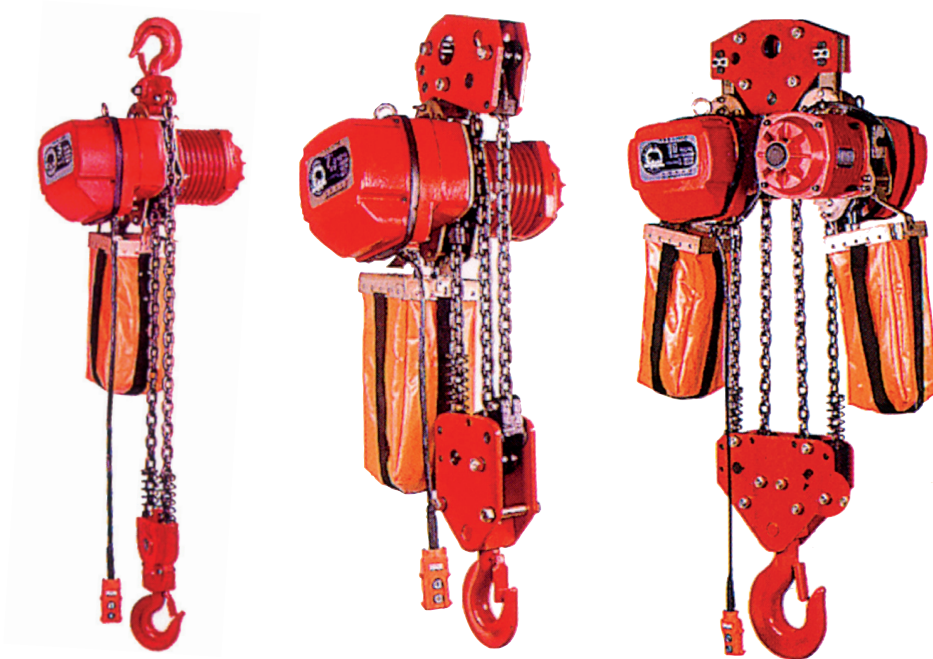

5 TON

7,5 TON

10 TON

YSS/YSD

Model	WLL	Chain / Ketting	Speed / Snelheid	Motor	ID	Falls/Parten	Weight	
Weight / Gewicht		m / min.						
	T			400 V	%			
			YSS	YSD				
200	2	10x30.2	6.6	6.6+2.2	3.7	40	1	125
300	3	10x30.2	4.3	4.3+1.4	3.7	40	2	140
500	5	11.2x34.4	2.6	2.6+0.9	3.7	40	2	153
750	7.5	11.2x34.4	1.8	1.8+0.6	3.7	40	3	195
1000	10	11.2x34.4	2.6	2.6+0.9	3.7x2	40	4	410

Dimensions / Afmetingen (mm)

Model	WLL	A	B	C	D	E	F	H	K	L	M	N		
	T	YSS	YSD	YSS	YSD									
0200	2	640	650	326	336	314	448	278	170	835	52	43	34	34
0300	3	640	650	326	336	314	448	340	108	960	52	43	34	34
0500	5	640	650	326	336	314	448	356	92	1030	62	45	45	45
0750	7.5	640	650	326	336	314	587	388	199	1050	75	57	84	48
1000	10	640	650	326	336	314	970	485	485	1270	100	68	-	60



Electrical Chain Hoist Elektrische Kettingtakel

YSE • 400V / 3ph / 50Hz

FEATURES

- Slipclutch serves as overload and up/down limiter
- Galvanized load chain according to EN818-7
- Electrical and mechanical brakes
- Lifting height 3 m standard
- Control height 2,5 m standard
- With top and bottom hook
- Chain bag (up to 3 m standard)
- Other lifting height available
- Push-button control with emergency stop
- High duty rating
- Control voltage 48V
- Power supply 400V / 3ph / 50Hz

FEATURES

- Voorzien van slipkoppeling die functioneert als overlastbeveiliging en eindschakelaar
- Verzinkte lastketting volgens EN 818-7
- Met drukknopkast inclusief noodstop
- Voedingsspanning 400V / 3ph / 50Hz
- Elektrische rem
- Hijshoogte 3 m standaard
- Bedieningshoogte 2,5 m standaard
- Met boven- en onderhaak
- Kettingzak (standaard t/m 3 m)
- Elke andere hijshoogte leverbaar
- Hoge inschakelduur
- Stuurspanning 48V

YSE

Model	WLL	Chain / Ketting	Speed / Snelheid	Motor	ID	Falls / Parten	Weight / Gewicht
	T	mm	m / min.	kW	%		kg
YSE-050	0,5	7.1x20.2	6.7	1	40	1	50.5
YSE-100	1	7.1x20.2	4.7	1	40	1	50.5
YSE-200	2	7.1x20.2	2.3	1	40	2	60.5
YSD-050-E	0,5	7.1x20.2	6.7+2.2	1	40	1	51
YSD-100-E	1	7.1x20.2	4.7+1.6	1	40	1	51
YSD-200-E	2	7.1x20.2	2.3+0.8	1	40	2	61

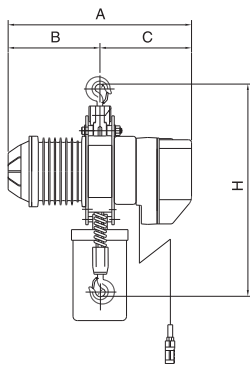

YSF

Single Phase Electrical Chain Hoist Lichtnettakel

YSF • 230V / 1ph / 50Hz

Electrical chain hoist with single speed lifting and a duty cycle of 15%. Power supply 230V / 1ph. Control voltage 230V.

Lichtnettakels met enkele snelheid en een inschakelduur van 15%. Voeding 230V / 1ph. Stuurspanning 230V.

YSF

Model	WLL	Chain / Ketting	Speed / Snelheid	Motor	ID	Falls / Parten	Weight / Gewicht
	T	mm	m / min.	kW	%		kg
YSF-050	0,5	7.1x20.2	6.7	1	15	1	50.5
YSF-100	1	7.1x20.2	4.7	1	15	1	50.5
YSF-200	2	7.1x20.2	2.3	1	15	2	60.5

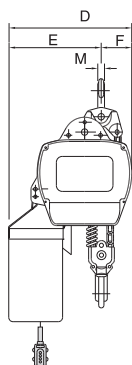

YSE

YSE/YSF

Model	WLL	Dimensions / Afmetingen (mm)							
	T	A	B	C	D	E	F	H	M
YSE-050	0,5	505	245	260	240	115	125	560	22
YSE-100	1	505	245	260	240	115	125	560	22
YSE-200	2	505	245	260	240	175	65	710	26.5
YSD-050-E	0,5	548	288	260	240	115	125	560	22
YSD-100-E	1	548	288	260	240	115	125	560	22
YSD-200-E	2	548	288	260	240	175	65	710	26.5
YSF-050	0,5	548	288	260	240	115	125	595	22
YSF-100	1	548	288	260	240	115	125	595	22
YSF-200	2	548	288	260	240	175	65	745	26.5



Motorized Trolley Elektrische Loopkat

YSMT/YSMT • 400V / 3ph / 50Hz YFMT • 230V / 1ph / 50Hz

FEATURES

- Track width adjustable
- Suitable for INP-IPE profiles
- Secured against wheel breakage
- Brake motor
- Duty rating 30%
- 2-button push-button control with emergency stop
- Extension axles available
- 48V control power
- 400V / 3ph / 50Hz
- Also available for 230 V / 1ph / 50 Hz power supply (YFMT)

EIGENSCHAPPEN

- Instelbare flensbreedte
- Geschikt voor INP-IPE profielen
- Met wielbreuksteunen
- Remmotor
- Inschakelduur 30%
- 2-knops drukknopkast met noodstop
- Verlengassen verkrijgbaar
- Stuurstroombediening 48V
- 400V / 3ph / 50Hz
- Ook leverbaar voor voedingsspanning 230V / 1ph / 50Hz (YFMT)

YSMT IS WITH SINGLE SPEED
YSMT IS MET ENKELE SNELHEID

YSMT IS WITH DOUBLE SPEED
YSMT IS MET DUBBELE SNELHEID

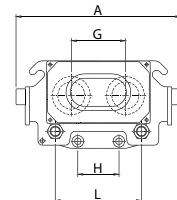
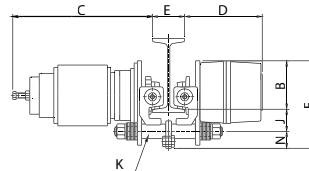

YSMT/YSMT/YFMT

SWL	Dimensions / Afmetingen (mm)					Speed / Snelheid m / min. (YSMT / YSDMT)	Motor kW	Weight / Gewicht kg
	A	B	C	D	E			
0.5/1	295	541	345	196	75-125	20 / 20+7	0.25	40
2	323	567	358	209	100-150	20 / 20+7	0.25	45
3	359	662	417	245	125-175	20 / 20+7	0.6	65
5	389	673	422	251	125-175	20 / 20+7	0.6	89
7.5	454	736	564	271	150-200	13 / 13+7	0.9	155
10	560	878	615	263	150-200	15 / 15+5	1.5	218

RM

Eye Nut Oogmoer

FEATURES

- An octagonal shape symbolizing quality class 8
- Coloured red, the identification colour of quality class 8
- Reliable operations certification by the respective technical committee
- It does not automatically adjust to pull
- Available in M06-100kg up to M48-8000kg
- Grade 80

EIGENSCHAPPEN

- Een achtoekige vorm symboliseert kwaliteitsklasse 8
- De kleur rood identificeert kwaliteitsklasse 8
- Tijdens vervoer draaibare bewegingen vermijden
- Uitsluitend te gebruiken bij rechtstandig gebruik
- Beschikbaar van M06-100kg tot en met M48-8000kg
- Grade 80



RS

Eye Bolt Oogbout

FEATURES

- An octagonal shape symbolizing quality class 8
- Coloured red, the identification colour of quality class 8
- Reliable operations certification by the respective technical committee
- It does not automatically adjust to the pull
- Available in M06-100kg up to M48-8000kg
- Grade 80

EIGENSCHAPPEN

- Een achthoekige vorm symboliseert kwaliteitsklasse 8
- De kleur rood identificeert kwaliteitsklasse 8
- Tijdens vervoer draaibare bewegingen vermijden
- Uitsluitend te gebruiken bij rechtstandig gebruik
- Beschikbaar van M06-100kg tot en met M48-8000kg
- Grade 80



VRM

Eye Nut Oogmoer

FEATURES

- Star point eye nut in star shaped design
- Striking fluorescent pink powder coating
- Available in M06-100kg up to 4500kg
- Grade 100

EIGENSCHAPPEN

- Starpoint oogmoer in stervorming ontwerp
- Uitgevoerd in sterk fluorescerend roze poedercoating
- Beschikbaar van M06-100kg tot en met M48-4500kg
- Grade 100



More technical data and information over the RUD products available on request.
Meer informatieve of technische vragen over RUD producten op aanvraag.

VRS-F

Eye Bolt Oogbout

FEATURES

- Star point eye bolt with star key in star shaped design
- Forged material, high tensile 100% electro-magnetic, crack detected
- Striking fluorescent pink powder coating
- Safety factor 4:1
- Available in M06-100kg up to M48-12000kg
- Grade 100

EIGENSCHAPPEN

- Starpoint oogbout met sleutel in stervormig ontwerp
- Gesmeed materiaal, hoge treksterkte 100% elektromagnetisch op haarscheuren beproeft
- Uitgevoerd in sterk fluorescerend roze poedercoating
- Veiligheidsfactor 4:1
- Beschikbaar van M06-100kg tot en met M48-12000kg
- Grade 100



VLBG plus

Load Ring Draaibare Hijsoog

FEATURES

- Suitable for all loads which swivel
- With a fully captive but easy to demount, 100% crack detected hexagon head cap bolt
- Not suitable for swiveling under full load
- Load ring is storable and pivots in all directions
- Available in M08-300kg up to M48-20000kg
- Grade 100

EIGENSCHAPPEN

- Geschikt voor alle draaibare lasten
- Uitgevoerd met een volledig ingesloten maar makkelijk te demonteren 100% op haarscheuren beproefde zeszijdige bout
- Niet geschikt om vollast te draaien
- Het hijsoog is wegklapbaar en draait in alle richtingen
- Beschikbaar van M08-300kg tot en met M48-20000kg
- Grade 100



VWBG

Lifting Point Load Ring Draaibare Oogbout

FEATURES

- Lifting point load ring, suitable for all loads which swivel and tilt
- Can be loaded in all directions, not suitable for swiveling under full load
- Easy to assemble, can also be supplied with variable thread lengths on request
- Available in M08-300kg up to M30-5000kg
- Grade 100

EIGENSCHAPPEN

- Hijspunt met lastoog, geschikt voor alle draaibare en buigzame lasten
- In alle richtingen belastbaar, niet geschikt om onder vollast te draaien
- Eenvoudig te monteren,
- Variabele boutlengte mogelijk op aanvraag
- Beschikbaar van M08-300kg tot en met M30-5000kg
- Grade 100



VIP

Chain Slings VIP from RUD by Holland Hoisting!

Do you perform lifting work in very high temperatures? Then the average load chain and components does not suffice.

Because you want to carry out your work as safely as possible and do not want to pay too much, we have introduced RUD VIP load chain and components into our product range. The VIP range is usable up to 400°C!

This is your ideal tool for working in high temperatures, with the best value for money. The VIP range is usable for all sorts of lifting, this way you do not need to buy extra lifting material.

More technical data and information over the RUD products available on request.

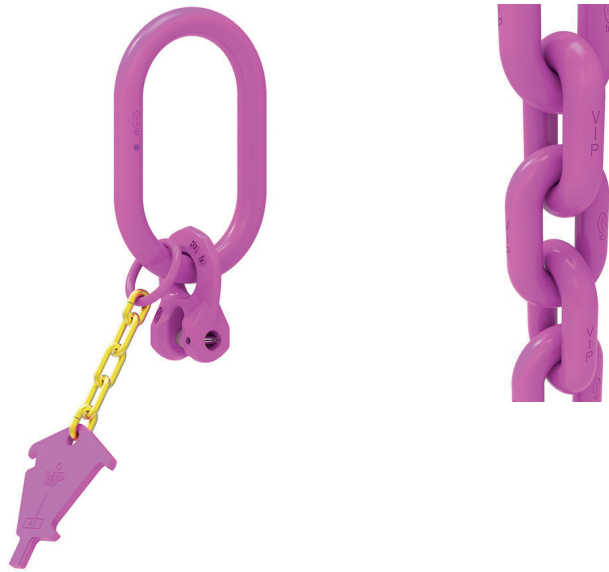

VIP

Kettingwerken VIP van RUD door Holland Hoisting!

Voert u regelmatig hijswerkzaamheden uit in zeer hoge temperaturen? Dan voldoen de doorsnee hijsketting en componenten meestal niet.

Omdat u zo veilig mogelijk uw werk wilt uitvoeren en niet teveel wilt betalen, hebben wij het RUD VIP-programma opgenomen in ons assortiment Kettingwerk & Componenten. Het VIP programma is te gebruiken in temperaturen van tot wel 400°C!

Dit is uw ideale hulpmiddel bij werkzaamheden in extreme hitte, met een uitstekende prijs/kwaliteits-verhouding. Het VIP-programma is ook prima te gebruiken in algemene hijsituaties, waardoor u geen dubbele hijsgereedschappen hoeft aan te schaffen.

Meer informatie of technische vragen over RUD-producten op aanvraag.





The official dealer from:
Officiële dealer van:



KITO



RUD

Dealer

All information in this catalogue is given under reserve
Alle in deze catalogus vermelde gegevens zijn onder voorbehoud